

# ECLISSE SYNTESIS® LINE BATTENTE DOUBLE

## OPENINGS

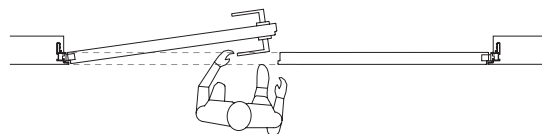

**LEFT PUSH DOOR - FIXED RIGHT DOOR**



**LEFT PULL DOOR - FIXED RIGHT DOOR**

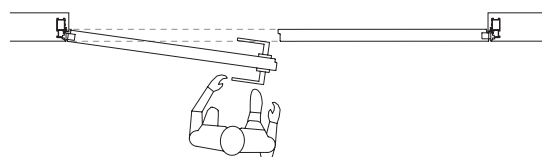

**RIGHT PUSH DOOR - FIXED LEFT DOOR**

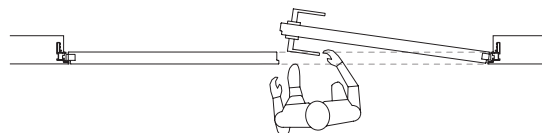

**RIGHT PULL DOOR - FIXED LEFT DOOR**

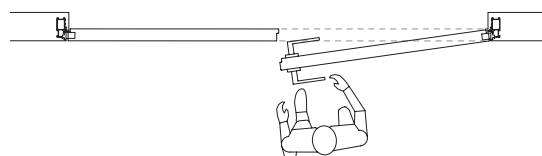

ECLISSE SYNTESIS® LINE BATTENTE DOUBLE is available only with header.  
The fixed door is kept closed with a latch (supplied with the door panel).

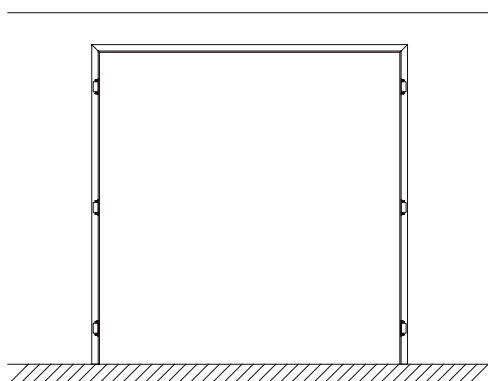

With header

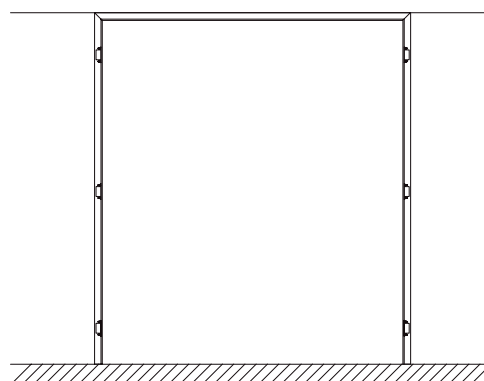

With header  
flush to ceiling

# ECLISSE SYNTESIS® LINE BATTENTE DOUBLE

## APPLICATIONS

Dimensions are given in mm

The frame fits both stud and solid wall.

For solid wall 6 clamps are cemented in the special spaces created in the wall.

For stud wall the frame is fixed with screws to the wood or metal structure through the existing holes.

### FIXED LEFT DOOR

### RIGHT PUSH DOOR OR PULL DOOR

#### Frame on solid wall

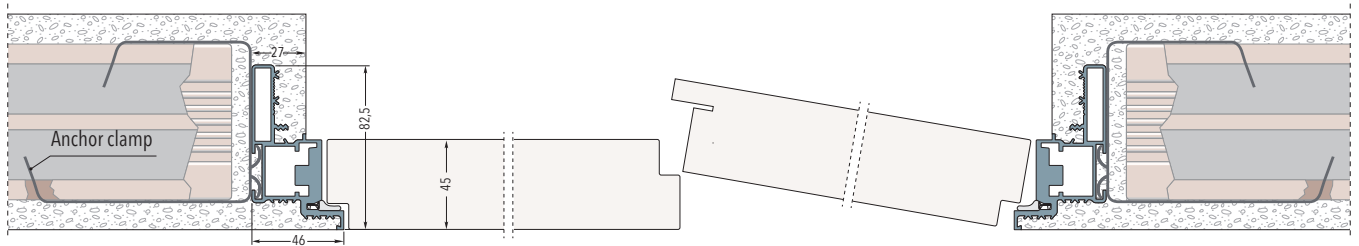

#### Frame on stud wall with one plasterboard layer - Finished wall thickness 100 mm

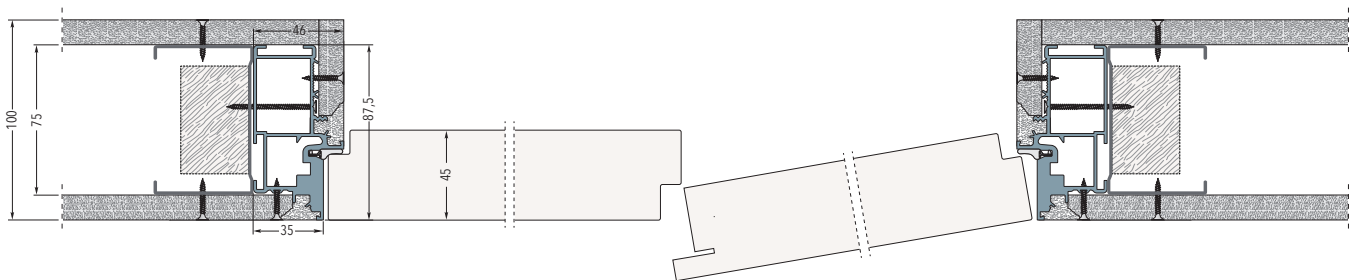

#### Frame on stud wall with two plasterboard layers - Finished wall thickness 100 mm

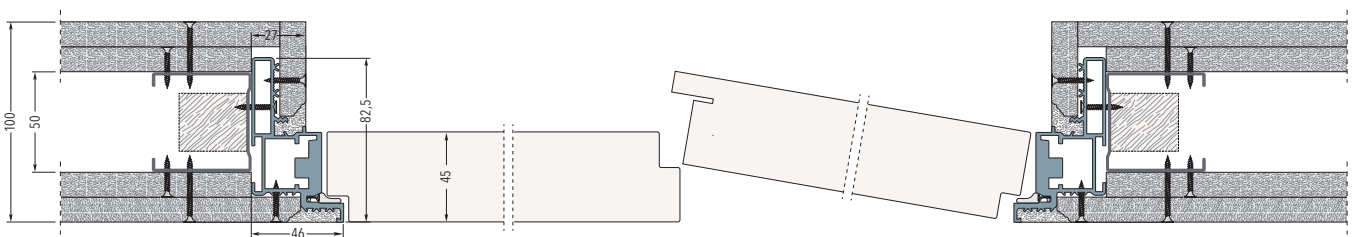

#### Frame on stud wall with two plasterboard layers - Finished wall thickness 125/150 mm

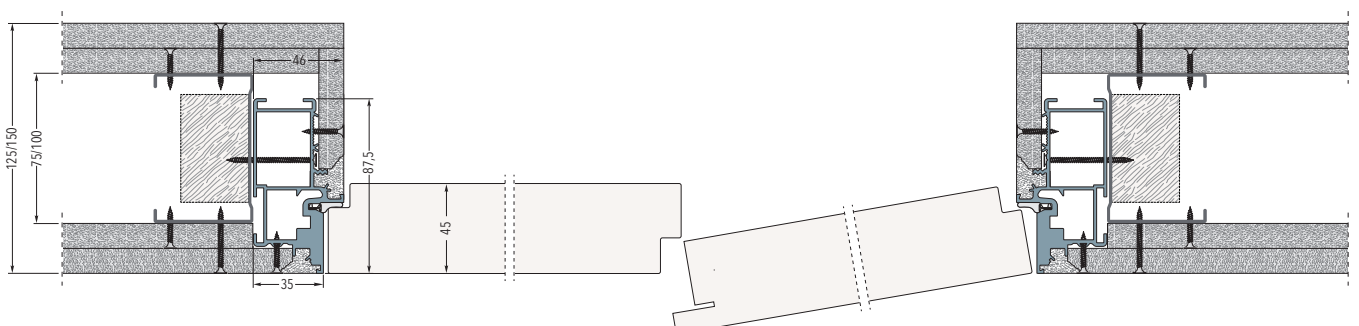

# ECLISSE SYNTESIS® LINE BATTENTE DOUBLE

SIZES - FRAME WITH HEADER

## PUSH DOOR

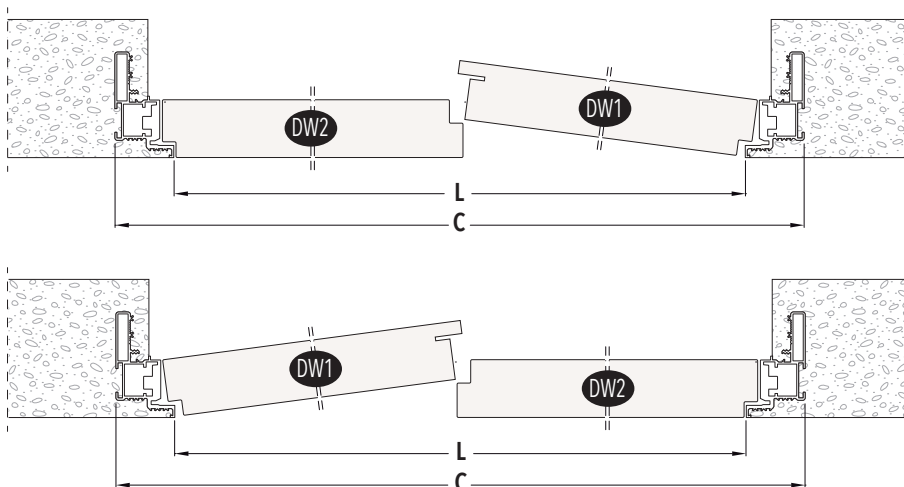
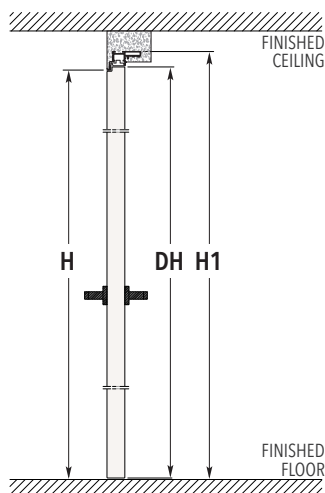

## PULL DOOR

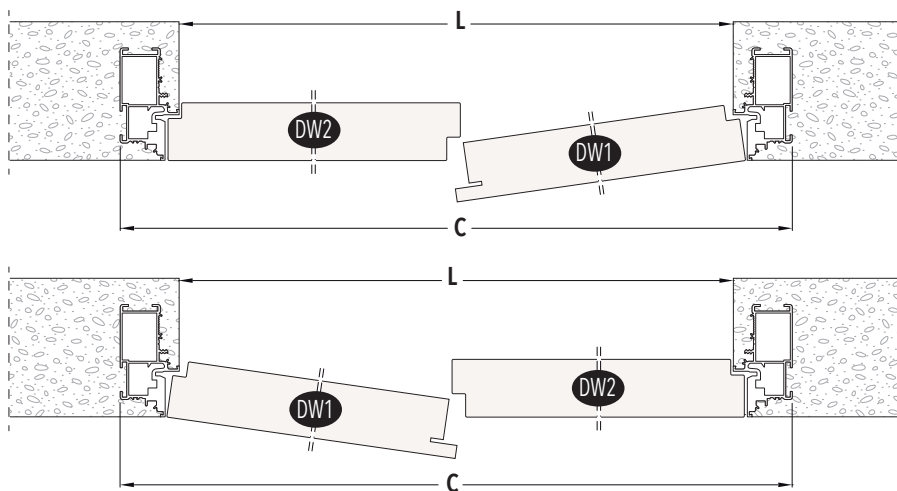
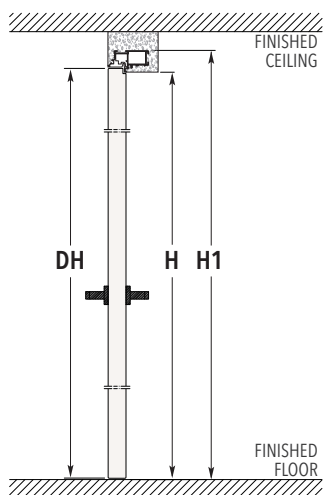

## SIZES - FRAME WITH HEADER

PASSAGE SIZE <b>L x H</b>	OVERALL DIMENSIONS <b>C x H1</b>	DOOR PANEL - Thk. 45 mm		
		<b>DW1</b>	<b>DW2</b>	<b>DH</b>
1200 x 2100/2400	1292 x 2146/2446	606	616	2104/2404
1300 x 2100/2400	1392 x 2146/2446	656	666	2104/2404
1400 x 2100/2400	1492 x 2146/2446	706	716	2104/2404
1500 x 2100/2400	1592 x 2146/2446	756	766	2104/2404
1600 x 2100/2400	1692 x 2146/2446	806	816	2104/2404
1700 x 2100/2400	1792 x 2146/2446	856	866	2104/2404
1800 x 2100/2400	1892 x 2146/2446	906	916	2104/2404
1900 x 2100/2400	1992 x 2146/2446	956	966	2104/2404
2000 x 2100/2400	2092 x 2146/2446	1006	1016	2104/2404

Dimensions are given in mm

### NOTES

- ▶ **Frame with header:** H1 is always 46 mm higher than H.
- ▶ It is possible to have asymmetrical door panels.
- ▶ Supplied as standard with 3 hinges. Max. door panel weight with 3 hinges: 50 kg.
- ▶ Available upon request with 4 hinges. Max. door panel weight with 4 hinges: 65 kg.
- ▶ Install at finished floor level.

### ACCESSORIES

- ▶ Door closer
- ▶ Self-closing door hinge